

Description

The DLSL05I is a low capacitance TVS diode array, utilizing leading monolithic silicon technology to provide fast response time and low ESD clamping voltage, making this device an ideal solution for protecting sensitive semiconductor components from damage. The DLSL05I complies with the IEC 61000-4-2 (ESD) standard with $\pm 30\text{kV}$ air and $\pm 30\text{kV}$ contact discharge. It is assembled into a lead-free SOT-23 package. It is designed to protect components which are connected to high speed interfaces and transmission lines from voltage surges.

Mechanical Characteristics

- ◆ Package: SOT-23
- ◆ Lead Finish: Matte Tin
- ◆ Case Material: "Green" Molding Compound.
- ◆ Moisture Sensitivity: Level 3 per J-STD-020
- ◆ Terminal Connections: See Diagram Below
- ◆ Marking Information: See Below

Dimensions and Pin Configuration

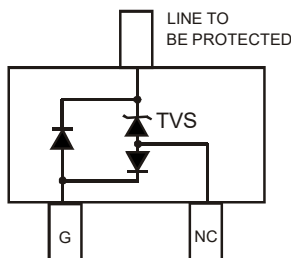

Circuit and Pin Schematic

Features

- ◆ 300W peak pulse power(8/20 μs)
- ◆ Protects two bi-directional lines
- ◆ Ultra low leakage: nA level
- ◆ Operating voltage: 5V
- ◆ Low capacitance for high-speed data line
- ◆ Low clamping voltage
- ◆ Complies with following standards:
 - IEC 61000-4-2 (ESD) immunity test
 - Air discharge: $\pm 30\text{kV}$
 - Contact discharge: $\pm 30\text{kV}$
 - IEC61000-4-5 (Lightning) 17A (8/20 μs)
- ◆ RoHS Compliant

Applications

- ◆ Cellular Handsets and Accessories
- ◆ Notebooks and Handhelds
- ◆ Portable Instrumentation
- ◆ Set Top Box
- ◆ Industrial Controls
- ◆ Server and Desktop PC
- ◆ High-speed data line
- ◆ LAN/WAN equipment

Marking Information

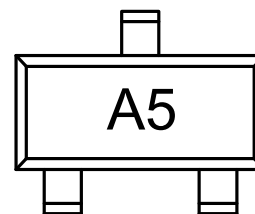

A5 = Device Marking Code

Ordering Information

Part Number	Marking	Packaging	Reel Size
DLSL05I	A5	3000/Tape & Reel	7 inch

Absolute Maximum Ratings ($T_A=25^{\circ}\text{C}$ unless otherwise specified)

Parameter	Symbol	Value	Unit
Peak Pulse Power (8/20 μs)	Ppk	300	W
ESD per IEC 61000-4-2 (Air)	VESD	± 30	kV
ESD per IEC 61000-4-2 (Contact)		± 30	
Operating Temperature Range	TJ	-55 to +125	$^{\circ}\text{C}$
Storage Temperature Range	Tstg	-55 to +150	$^{\circ}\text{C}$

Electrical Characteristics ($T_A=25^{\circ}\text{C}$ unless otherwise specified)

Parameter	Symbol	Min	Typ	Max	Unit	Test Condition
Reverse Working Voltage	VRWM			5	V	
Breakdown Voltage	VBR	6			V	IT = 1mA
Reverse Leakage Current	IR			0.5	μA	VRWM = 5V
Clamping Voltage	VC			9.5	V	I _{PP} = 1A (8 x 20 μs pulse)
Clamping Voltage	VC			11	V	I _{PP} = 5A (8 x 20 μs pulse)
Clamping Voltage	VC			18	V	I _{PP} = 17A (8 x 20 μs pulse)
Junction Capacitance	CJ		1	3	pF	VR = 0V, f = 1MHz

Typical Performance Characteristics (TA=25°C unless otherwise Specified)

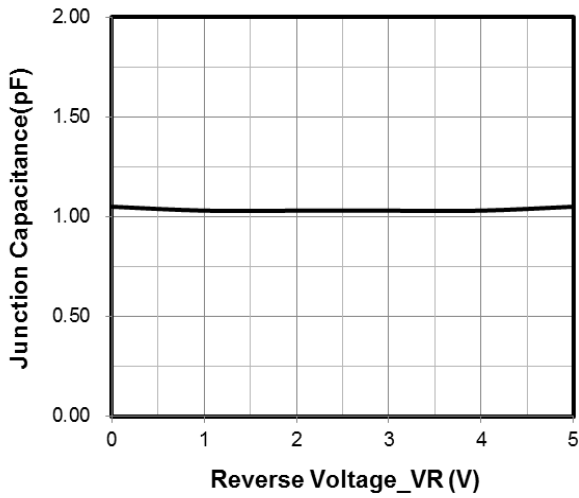

Junction Capacitance vs. Reverse Voltage

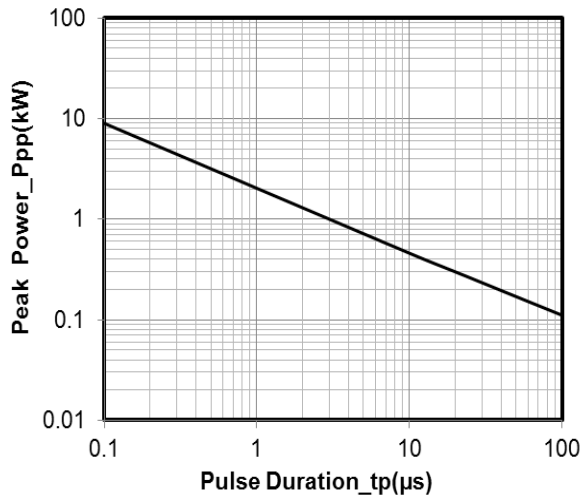

Peak Pulse Power vs. Pulse Time

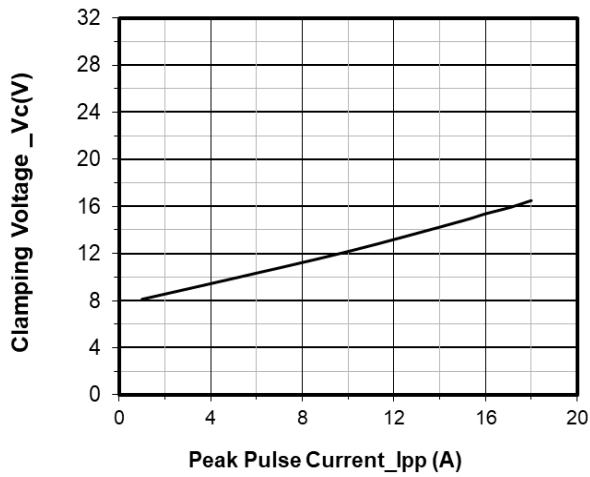

Clamping Voltage vs. Peak Pulse Current

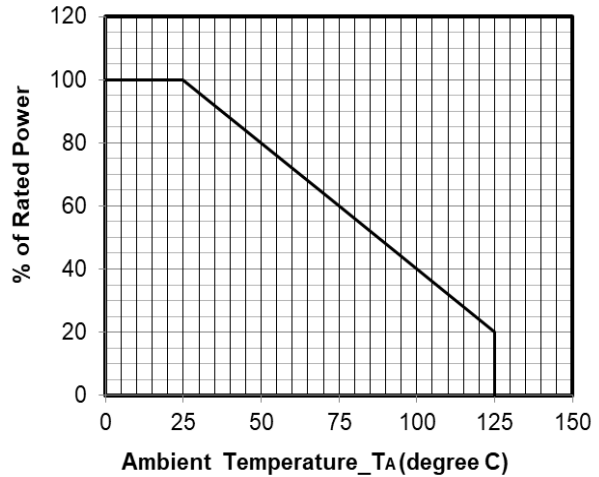

Power Derating Curve

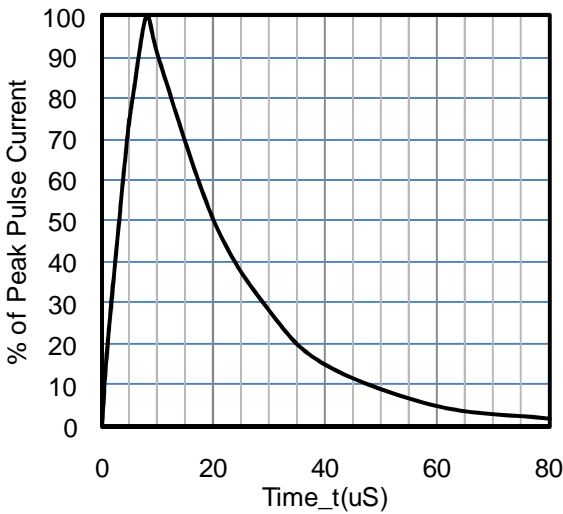

8X 20μs Pulse Waveform

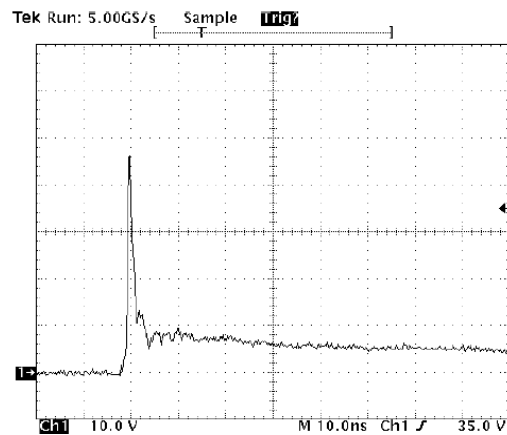

Note: Data is taken with a 10x attenuator

ESD Clamping Voltage

8 kV Contact per IEC61000-4-2

SOT-23 Package Outline Drawing

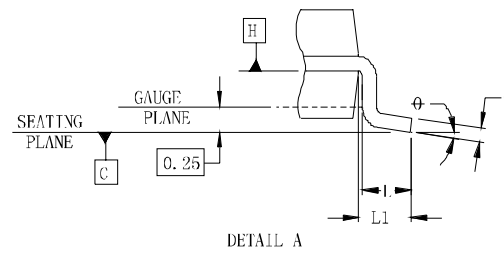
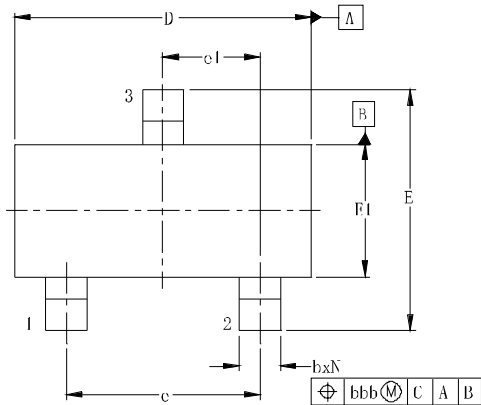

DIMENSIONS						
SYM	INCHES			MILLIMETERS		
	MIN	NOM	MAX	MIN	NOM	MAX
A	0.035	-	0.044	0.89	-	1.12
A1	0.000	-	0.004	0.01	-	0.10
A2	0.035	0.037	0.040	0.88	0.95	1.02
b	0.012	-	0.020	0.30	-	0.51
c	0.003	-	0.007	0.08	-	0.18
D	0.110	0.114	0.120	2.80	2.90	3.04
E	0.082	0.093	0.104	2.10	2.37	2.64
E1	0.047	0.051	0.055	1.20	1.30	1.40
e	0.075			1.90BSC		
e1	0.037			0.95BSC		
L	0.015	0.020	0.024	0.40	0.50	0.60
L1	0.022			0.55		
N	3			3		
ϕ	0°	-	8°	0°	-	8°
aaa	0.004			0.10		
bbb	0.008			0.20		

Suggested Land Pattern

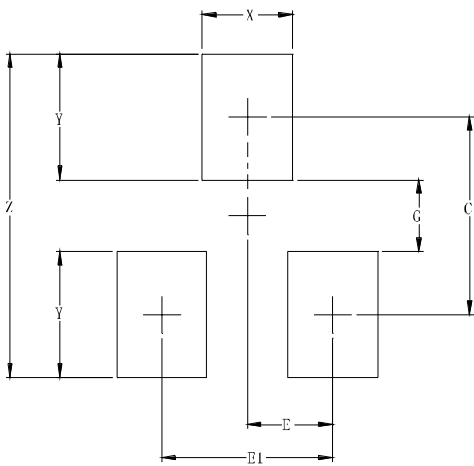

DIMENSIONS		
SYM	INCHES	MILLIMETERS
C	0.087	2.20
E	0.037	0.95
E1	0.075	1.90
G	0.031	0.80
X	0.039	1.00
Y	0.055	1.40
Z	0.141	3.60

Contact Information

Changzhou D-first Electronics CO.,Ltd.

www.first-electronic.com

Email: xhf@first-electronic.cn

Phone: +86 (0519) 8817 1671